

論文 / 著書情報
Article / Book Information

Title	Spiral Mecanum Wheel Achieving Omnidirectional Locomotion in Step-Climbing
Authors	Noriyuki Yamada, Hirotaka Komura, Gen Endo, Hiroyuki Nabae, Koichi Suzumori
Citation	Proceedings of the 2017 IEEE/ASME International Conference on Advanced Intelligent Mechatronics (AIM 2017), pp. 1285-1290
Pub. date	2017, 7
DOI	http://dx.doi.org/10.1109/AIM.2017.8014195
URL	http://www.ieee.org/index.html
Copyright	(c)2017 IEEE. Personal use of this material is permitted. Permission from IEEE must be obtained for all other uses, in any current or future media, including reprinting/republishing this material for advertising or promotional purposes, creating new collective works, for resale or redistribution to servers or lists, or reuse of any copyrighted component of this work in other works.
Note	This file is author (final) version.

Spiral Mecanum Wheel Achieving Omnidirectional Locomotion in Step-Climbing

Noriyuki Yamada¹, Hirotaka Komura¹, Gen Endo¹, Hiroyuki Nabae¹, Koichi Suzumori¹

Abstract—The vehicle using omnidirectional wheels has ability to move in all directions without changing the body direction unlike a normal four wheel drive vehicle. However most of omnidirectional vehicle are designed for using only on flat ground. In this paper, we propose a new type of omnidirectional wheel, “Spiral Mecanum Wheel”, which enables vehicle climb the step. This new wheel consists of spiral beams and many small rollers, and these small rollers are arranged along the spiral beams. When the vehicle with this spiral Mecanum Wheels moves in normal direction, the edge of the spiral moves to cover the step from above. We have performed the experiments using Spiral Mecanum Wheel and showing the wheel works very well. As a result, in the experiment using single Spiral Mecanum Wheel, this Spiral Mecanum Wheel climbed the step about 83% of the wheel diameter in normal direction motion. The vehicle with Spiral Mecanum Wheel climbed the step about 37% of the wheel diameter in tangential direction motion and 59% in normal direction.

I. INTRODUCTION

Omnidirectional vehicles are widely used in many fields because they have an ability to move in all directions without turning[1],[2],[3],[4]. This is different from the general four wheel drive vehicle. When a wheeled vehicle turns across narrow space, the four wheel drive vehicles need turning the steering wheel many times, however omnidirectional vehicles don't need. So omnidirectional vehicles can move to the desired location quickly. Omni wheel[5],[6], Mecanum wheel[7],[8], and active caster[9] are examples of omnidirectional wheel mechanisms.

Omni wheel has the free rotating rollers which shape are like barrel on the circumference of a wheel. They are attached perpendicular to the wheel's rotation direction and allow the wheel to slide laterally. By using three or more wheels and placing Omni Wheel with all angle differently, the vehicle can achieve omnidirectional motion. Mecanum wheel mechanism is similar to Omni wheel mechanism in point of possessing passive rollers on the circumference of the wheel. However the rollers are attached 45° to the wheel's rotation direction. Normally, the vehicle using Mecanum wheel has four wheels. These wheels layout is the same as the four wheel drive like a car. For example, when the robot wants to move laterally, the robot should rotate the front and rear wheels in opposite directions. Thus, by controlling a rotation direction and speed of the four wheels, vehicles with Mecanum Wheels are capable of moving in all direction. Active Caster wheel has two motors per one wheel, one for steering and the other for

driving. When a vehicle having four Active Caster wheels moves, the direction of four wheels are the same and the vehicle can move to the same direction. However, these omnidirectional wheels are designed for the movement on flat plane. Many kind of omnidirectional robots are designed to resolve this problem so far. The Semi-Circular Mecanum wheel[10](Fig.1a) is exploited for an omnidirectional vehicle. This wheel is composed of two Mecanum Wheel cut in half and arranged by shifting the position of them. In this study, the wheel diameter was 150 mm, and the vehicle succeeded to climb the step whose height was 66% of the wheel diameter by moving longitudinally. On the other hand, the climbable step height in lateral direction was 33% of the wheel diameter. Another prior work is the “Omni-Balls Vehicle”[11](Fig 1b). Omni-Ball is formed by two passive rotational hemispherical wheels and one active rotational axis. The vehicle with this wheel has a higher level of ability for step climbing than Omni Wheel. When the wheel diameter is 80 mm, the vehicle can climb the step whose height was 29% of the wheel diameter.

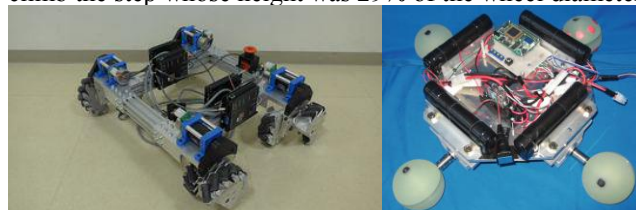

(a)Semi-Circular mecanum wheel vehicle[10] (b)Omni-Balls vehicle[11]

Figure 1. Examples of omnidirectional vehicle with specialized designed wheel

TABLE I. PERFORMANCE COMPARISON OF SOME TYPES OF OMNIDIRECTIONAL WHEEL ROBOTS

	Conventional Mecanum	Semi-Circular Mecanum	Omni-ball
Step height / wheel diameter (tangential)	20%[12]	66%	29%
Step height / wheel diameter (normal)	7%	33%	29%

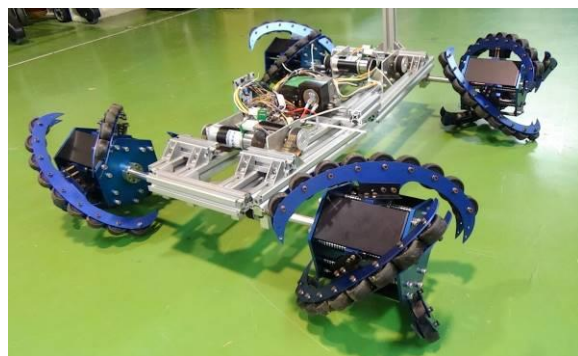

Figure 2. Spiral Mecanum Wheel Vehicle

¹ N. Yamada, H. Komura, G. Endo, H. Nabae and K. Suzumori are with School of Engineering, Tokyo Institute of Technology, 2-12-1 Ookayama, Meguroku, Tokyo, 152-8552, Japan, gendo, nabae, suzumori at mes.titech.ac.jp

Table I shows the performance comparison of some types of omnidirectional wheel robots. However this mechanism is more complicated than Omni Wheel. The vehicle with Active Caster wheel is also complicated. Based on these reasons, the vehicle with Mecanum Wheel has the simplest mechanism, control system, and wheel layout. In this paper, we proposed a vehicle with new shape of Mecanum Wheel (Fig.2), which can climb the high step in omnidirectional motion, and verified its performance by some experiments.

II. STRUCTURE OF SPIRAL MECANUM WHEEL

On flat plane, many small rollers on circumference of spiral Mecanum wheel mechanism act as same as rollers of Mecanum wheel mechanism, so the vehicle with these four wheel can move in all direction like Mecanum Wheel. This wheel has passive deforming mechanism which allows the vehicle climb high step, as mentioned in bellow (Fig.3).

A. Barrel Shaped Roller Unit

In this wheel, there are three “Barrel Shaped Roller Unit”(hereafter referred to as BSRU) which is composed many free rotating small rollers and a component like a bow. This component is the shape of the curve designed by reference to the roller whose shape is the ellipse in conventional Mecanum Wheel. The diameter of free rollers is related to the ability to move on uneven terrain. Thus, in previous research[13], it was tried to make the free rollers larger. However there was interference between the each roller when the number of rollers is less than four as shown in Fig.4. Therefore, we avoided the interference by reproducing the grounded portion in omnidirectional motion. However, the performance of the vehicle with this wheel is as same as conventional type wheel in step-climbing. We paid attention to the claw-like shape of spiral beam. We arranged the rollers as the rotation direction becomes parallel to the spiral beam as shown in Fig.5. As a result, the rotation direction of the wheel is reversed although the movement direction of the vehicle is the same because the free rotation direction of rollers have changed. And the edge of BSRU can make a contact with the top of the step, even if the step height is higher than wheel radius.

It is feasible to design Spiral Mecanum Wheel when the number of BSRU is less than three, however we need to design BSRU twist as a spiral. Strictly speaking, we also need to design BSRU twist as a spiral when the number of BSRU is three, of course more than three. However BSRU can be approximated to a straight shape since there is no effect and any of the small rollers is always grounded in omnidirectional motion. Therefore, we chose three BSRU which is the simplest and minimum arrangement

Both edges of BSRU possesses claw-like shape in order to make a contact with the top plane of the step. The maximum step height that this Spiral Mecanum Wheel can climb is obtained by subtracting from wheel diameter to small roller radius and the thickness of BSRU geometrically as shown in Fig.6.

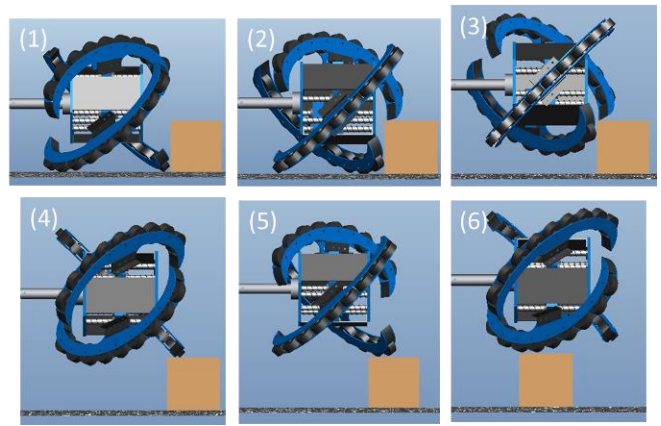

Figure 3. Image of Spiral Mecanum Wheel movement when the wheel reaches and climbs the step

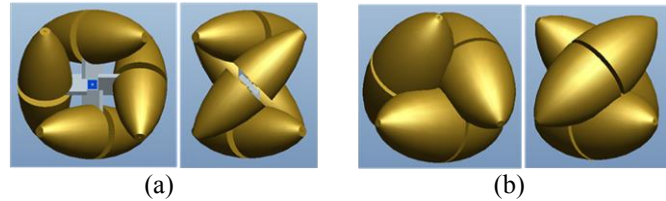

Figure 4. Image of conventional Mecanum Wheel, (a): Four rollers, (b): Three rollers

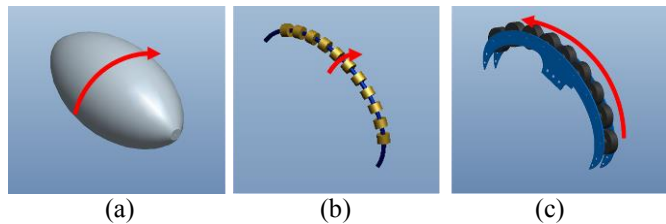

Figure 5. Image of Barrel-Shaped Roller, (a): Conventional, (b): Old Spiral type, (c): BSRU, (Red arrow: Free rotation direction of rollers)

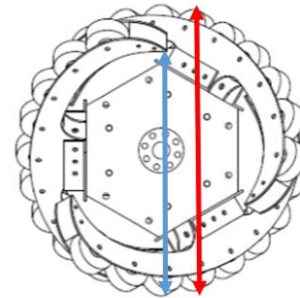

Figure 6. Side view of Spiral Mecanum Wheel (Red arrow: Wheel diameter, Blue arrow: The maximum height that the wheel can catch and climb a step)

B. Mechanism of deformation passively

Each three BSRU can be moved passively to the axial direction of the wheel as shown in Fig.7. Each BSRU is held by two shafts and can move freely in the axial direction by a linear bush. There are two springs per one shaft and these are holding BSRU from both sides. When the wheel touch the step, the spring shrinks by the reaction force from the step. Otherwise, BSRU is in the middle of the shaft.

If the spring is too hard, the wheel cannot climb the step because the wheel cannot deform when the wheel hits the step

and the edge of the wheel does not make a contact with top plane of the step. Then we decided the spring constant based on traction force of one wheel when the wheel moves with no-load.

In case of the step height is lower than 33 mm, this Spiral Mecanum Wheel can climb the step without deformation as shown in Fig.8. It is possible that the step enters the gap between two BSRU (Fig.8 (2)). Next, if only one small roller is on the ground (Fig.8 (3)), it is possible to obtain the traction force in normal direction.

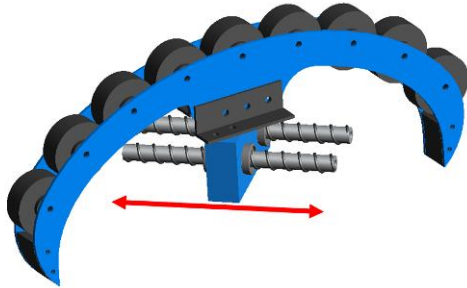

Figure 7. Overview of BSRU and linear mechanism (Red arrow: movement direction passively)

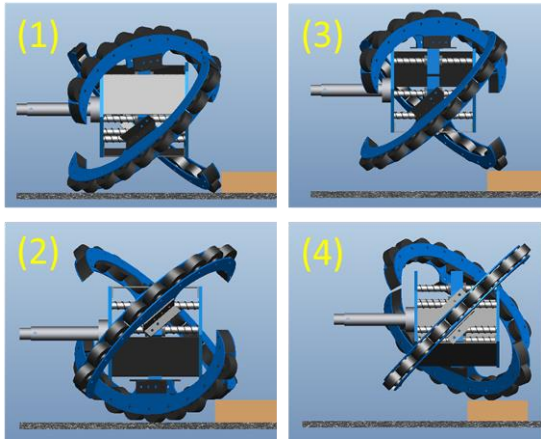

Figure 8. Image of Spiral Mecanum Wheel movement when the wheel climbs the step without deformation (height : 33 mm)

III. DESIGN OF SPIRAL MECANUM WHEEL VEHICLE

Fig.9 shows an overview of Spiral Mecanum Wheel, and specifications of the wheel are shown in TABLE II. Fig.10 shows an overview of the vehicle with four Spiral Mecanum Wheels, and specifications of the vehicle are shown in TABLE III. Four motors are not connected to the drive shaft directly to prevent motors from contacting with the ground or obstacles. They transmit power to the wheel with a timing belt and pulley. The drive shaft must have sufficient length to avoid contact with the body when the wheel is deformed in the axial direction. In order to achieve the omnidirectional motion, the left and right wheels must be in a mirror image relation. In addition, to get traction force more reliably on rough terrain, the suspension mechanism is mounted in this vehicle as shown in Fig.11. We divided the vehicle into half and connect front half and rear half by rotational joint in roll axis. Therefore, all of four wheels are always grounded in an uneven terrain. Fig.12 shows the control system of this vehicle. We control the angular velocities of four individual wheels.

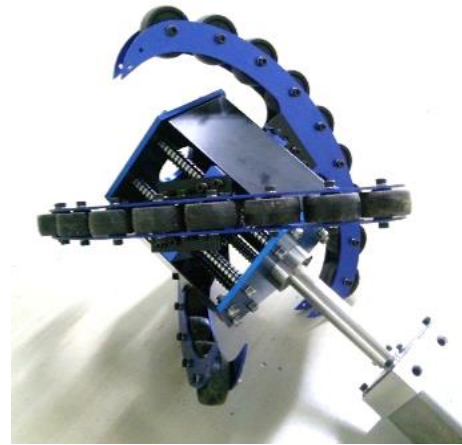

Figure 9. Overview of Spiral Mecanum Wheel

TABLE II. SPECIFICATIONS OF SPIRAL MECANUM WHEEL

Weight	1.5 kg
Wheel diameter	254 mm
Wheel width	234 mm
Small roller diameter	38 mm
Small roller width	20 mm
Spring constant	0.60 N/mm
Deformation distance	40 mm

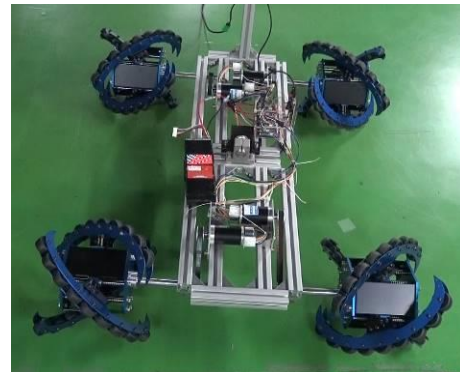

Figure 10. Topview of the vehicle with four Spiral Mecanum Wheels

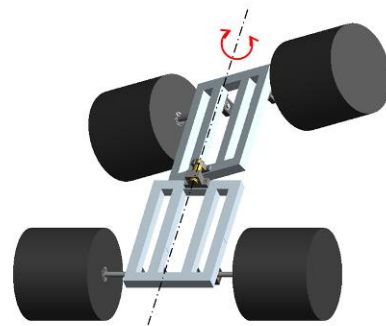

Figure 11. Suspension Mechanism of the vehicle

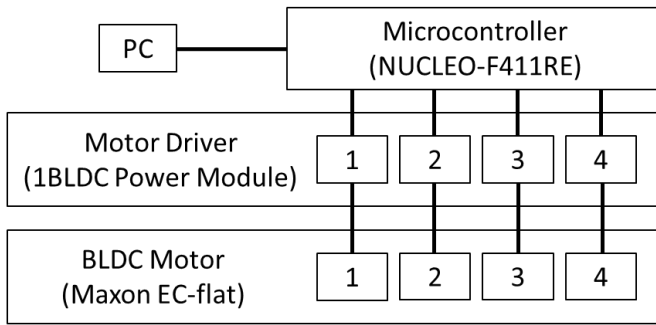

Figure 12. Control system of the vehicle

TABLE III. SPECIFICATIONS OF THE VEHICLE WITH SPIRAL MECANUM WHEEL

Weight(with battery)	10 kg
Height	300 mm
Length	850 mm
Width	850 mm
Minimum ground clearance	107 mm
Maximum velocity	2 m/s

IV. EXPERIMENT

In order to confirm the performance of the prototype model of this vehicle with Spiral Mecanum Wheel, some transfer experiments were done.

A. Omnidirectional motion on flat plane

On the flat plane, this vehicle can move to front and back, left and right, diagonally, turning as well as conventional Mecanum Wheels as shown in Fig.13.

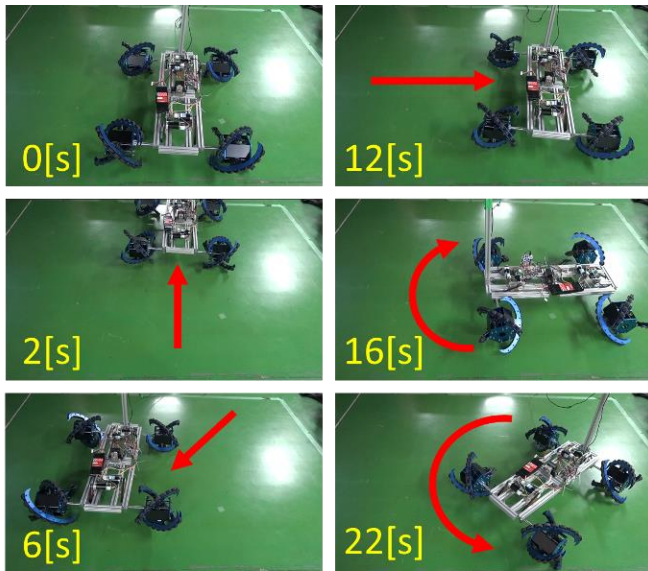

Figure 13. Omnidirectional motion on flat plane (Red arrow: Movement direction)

B. Step climbing experiment of single Spiral Mecanum Wheel

This experiment was done to evaluate the performance of single Spiral Mecanum wheel. Fig 14 shows the testbed of single wheel experiment. This testbed is composed of three

linear guides, so this testbed can move freely in the three directions. The wheel was mounted on this testbed through a block of aluminum. When the wheel reaches the step, since the traction force is generated by only one tested wheel, reaction force required for the spring in the wheel shrinking is insufficient. Thus, in this experiment, the wheel was pulled in normal direction by 4 kg force so as to make the same condition as the vehicle with four wheels. The wheel was tested in both tangential and normal directions. As a result, the wheel could climb the step maximum 212 mm in normal direction using the edge of BSRU and maximum 60 mm in tangential direction as shown in Fig.15 and Fig.16. In normal direction, two BSRU touch the step and the edge of the other BSRU is over the top of the step by the springs shrinking when the wheel reaches the step (Fig.16 0[s]). The edge of BSRU catches the step by the springs shrinking and the wheel lifts itself in accordance with rotation by the edge of BSRU as a fulcrum (Fig.16 1[s], 2[s], 3[s]). Even if only one small roller is grounded like Fig.16 4[s], it is possible to generate the traction force in normal direction.

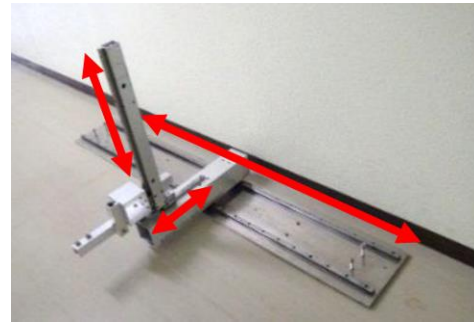

Figure 14. Overview of the testbed of single wheel experiment capable of moving in 3 dimensions (red arrows)

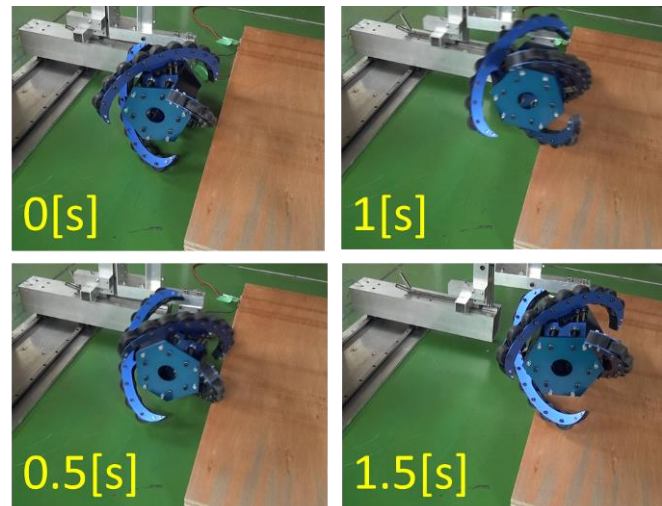

Figure 15. Motion of Spiral Mecanum Wheel in tangential direction with step climbing(height:60 mm)

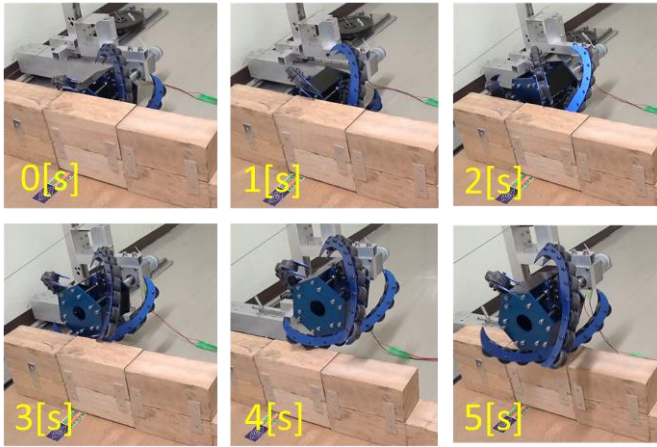

Figure 16. Motion of Spiral Mecanum Wheel in normal direction with step climbing(height:212 mm)

C. Step climbing motion with the Spiral Mecanum Wheel vehicle

Step climbing experiment of whole of Spiral Mecanum Wheel vehicle was done. As a result, it was succeeded to climb the step maximum 150 mm using the edge of BSRU as shown in Fig.17. The height of the step is lower than the experiment with only one wheel. It is considered that the drive shaft and lower surface of the vehicle hits the step and because the vehicle leans when it climbs the step. To resolve these problems, it is necessary to consider not only the shape of a wheel but also a vehicle. In Diagonal motion, the vehicle cannot climb the step completely because two wheels do not rotate. However since the wheel enters to the step obliquely, the edge of BSRU can make a contact with top plane of the step without deformation by springs.

In tangential direction motion(Fig.17(a)), After front wheels climb the step(Fig.17(a) 2), When two rear wheels climb the step, the corner of the step entered between two small rollers next to each other(Fig.17(a) 5). In normal direction motion(Fig.17(b)), first, the vehicle moved toward the step straight and two wheels made a contact with top plane of the step at almost the same time(Fig.17(b) 1,2). However, front wheel climbed earlier than rear wheel, since the phase of each wheel was not synchronized. The other wheel climbed the step immediately afterwards(Fig.17(b) 3,4,5). It shows that it is not necessary that two wheels catch the step simultaneously.

Though the minimum ground clearance of this vehicle is 107 mm, this vehicle could climb the step that height is 150mm. As shown in Fig.18, it is necessary to consider the inclination of the vehicle when the vehicle climbs the step. If the step is a small obstacle, the vehicle does not lean when the step is under the vehicle between the left and right wheels. In addition, it is considered that the vehicle less likely to climb the step because the spring becomes difficult to deformation by vehicle's weight when the axle is inclined.

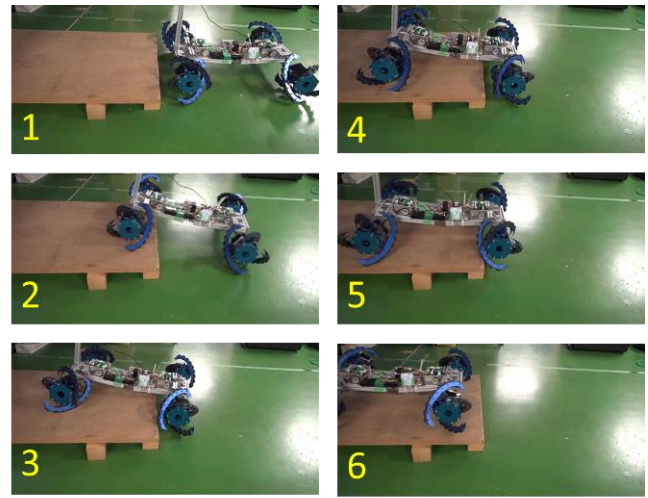

(a) Tangential direction motion (height: 95 mm)

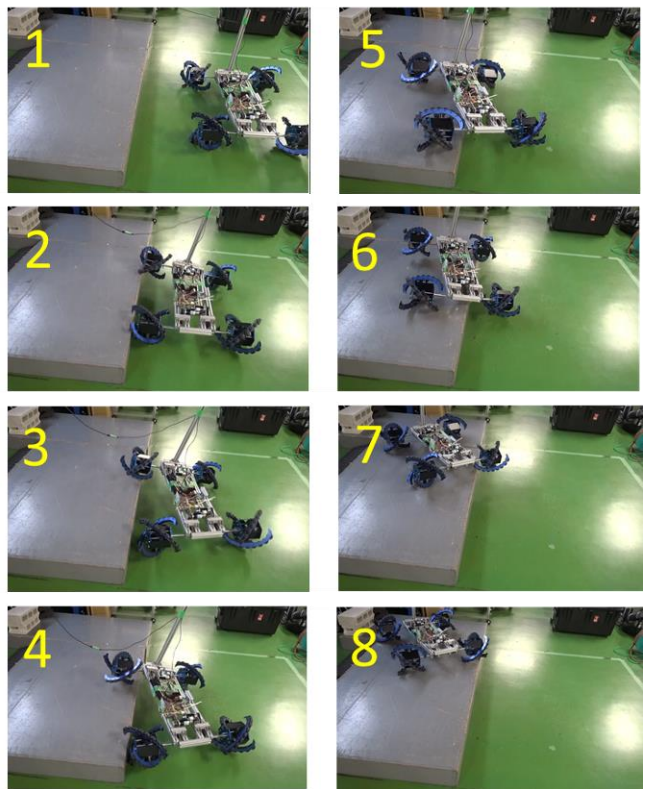

(b) Normal direction motion (height: 150 mm)

Figure 17. Omnidirectional motion of the vehicle with step climbing

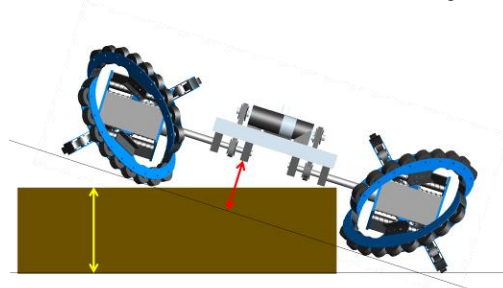

Figure 18. Front view of the vehicle with step climbing in normal direction (red arrow: the minimum ground clearance, yellow arrow: the step height)

The Spiral Mecanum Wheel can climb the step by deformation of the wheel with the spring passively. In this case, the deformation depends on the speed of the vehicle when they reach the step. The faster the vehicle moves, the higher step the vehicle can climb.

V. CONCLUSION

In this paper, we proposed a new type of Mecanum wheel, “Spiral Mecanum Wheel”, which can achieve omnidirectional motion and climb the high step. Then we explained in details the design of this Spiral Mecanum Wheel and discussed the performance of Spiral Mecanum Wheel by some experiment. As a result of experiments, the vehicle with this Spiral Mecanum Wheels can climb the higher step, especially normal directional movement, than previous researches. This vehicle climbed the step about 37% of the wheel diameter in tangential direction motion and 59% in normal direction. In the experiment using single Spiral Mecanum Wheel, this Spiral Mecanum Wheel climbed the step about 83% of the wheel diameter in normal direction motion. As a future plan, it is possible to refine the mechanism to achieve even higher step climbing ability. Furthermore, the body of the vehicle also can be refined in order to reduce the contact between the obstacles and the body.

ACKNOWLEDGMENT

Present study includes the result of Advanced Research and Education Program for Nuclear Decommissioning (ARED) entrusted to Tokyo Institute of Technology by the Ministry of Education, Culture, Sports, Science and Technology of Japan (MEXT).

REFERENCES

- [1] G. Ishigami, K. Iagnemma, J. Overholt, G. Hudas, “Design, Development, and Mobility Evaluation of an Omnidirectional Mobile Robot for Rough Terrain”, *Journal of Field Robotics* Volume 32, Issue 6, pages 880–896, 2015
- [2] OMNI-DIRECTIONAL LIFT TRUCK,
<http://www.airtrax.com/>
- [3] M. Tavakoli, C. Viegasa, “Analysis and application of dual-row omnidirectional wheels for climbing robots”, *Mechatronics* Volume 24 (2014) 436–448
- [4] C. Leng, J. Du, Q. Cao, X. Zhu, Z. Huang, “Development of an Omnidirectional AGV with Global Localization System”, *Mechanics and Materials* Vol. 302 (2013) pp 746-751
- [5] A control system for an omnidirectional mobile robot, Paromtchik, I.E.; Asama, H.; Fujii, T.; Endo, L.; *Control Applications*, 1999. Proceedings of the 1999 IEEE International Conference on Volume 2, 22-27 Aug. 1999 Page(s):1123 - 1128 vol. 2
- [6] S.O.C. Morales, G.B. Enríquez and F.T. Romero, “Design and Implementation of Model-Predictive Control With Friction Compensation on an Omnidirectional Mobile Robot,” *IEEE/ASME Transactions On Mechatronics*, vol. 99, pp. 1-10, 2013.
- [7] A. Ramirez-Serrano, R. Kuzyk, “Modified Mecanum Wheels for Traversing Rough Terrain”, 6 th International Conference on Autonomic and Autonomous Systems, IEEE Computer Society,97-103, 2010
- [8] J.E.M. Salih, M. Rizon and S. Yaacob, “Designing Omni-Directional Mobile Robot with Mecanum Wheel,” *American Journal of Applied Sciences*, vol. 3, pp. 1831-1835, 2006.
- [9] M. Udengaard, K. Iagnemma, “Design of an Omnidirectional Mobile Robot for Rough Terrain”, 2008 IEEE International Conference on Robotics and Automation, 1666-1671, 2008
- [10] M. Aoyama, K. Yoneda, “Development of decontamination robot with semi-circular omnidirectional wheels”, 2P1-Q01, JSME Conference on Robotics and Mechatronics, 2015 (in Japanese)
- [11] K. Tadakuma, R. Tadakuma, J. Berengeres, “Development of holonomic omnidirectional vehicle with “omni-ball”: Spherical wheels” In Proceedings of the IEEE/RSJ International Conference on Intelligent Robotics and Systems, 2007 (pp. 33–39).
- [12] Okatech MECBOT #007 Mecanum
<http://okatech.net/pdf/MECBOT007.pdf> (in Japanese)
- [13] K. Suzumori, N. Yamada, “Prototype of the new Mecanum Wheel with spiral wire lot structure”, The 32st Annual Conference of the Robotics Society of Japan, RSJ2014AC3D2-05, 2014 (in Japanese)